

Mechanically Jointed Rodless Cylinder **New**

Basic Type: $\varnothing 25$, $\varnothing 32$, $\varnothing 40$

RoHS

The mounting and performance are the same as before.

Weight

17% Reduced

Weight reduction is achieved through the configuration changes of the head cover and cylinder tubing.

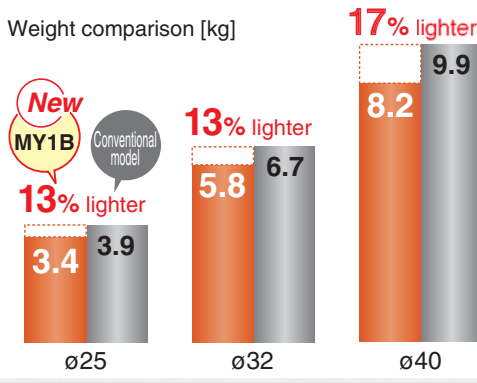

* Compared with L unit at 1000 strokes.

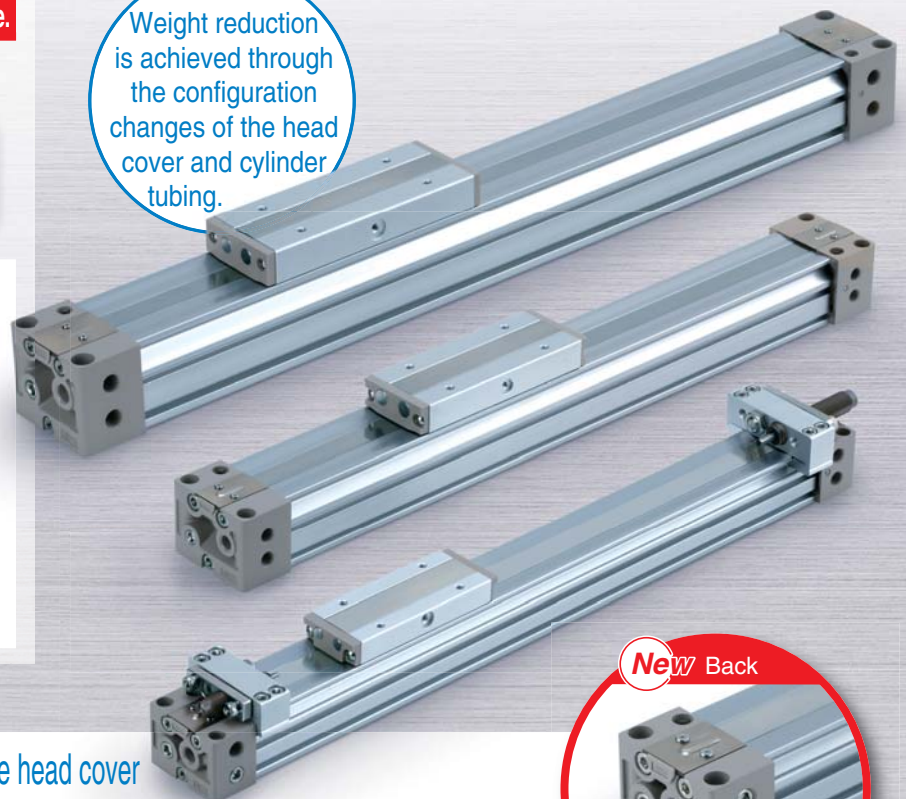

New Piping can be connected from 4 directions on the head cover

Head cover piping increased from 3 directions to 4 with improved piping flexibility. Increase in piping direction allows piping to meet the on-site installation conditions.

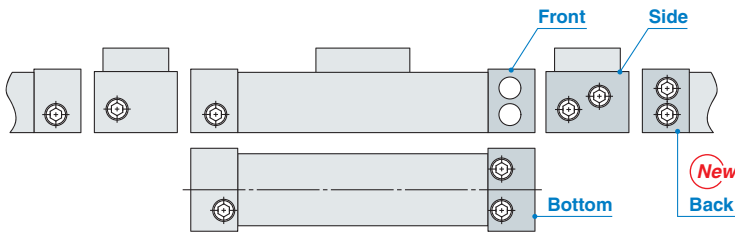

* With hexagon socket taper plug except port 1.

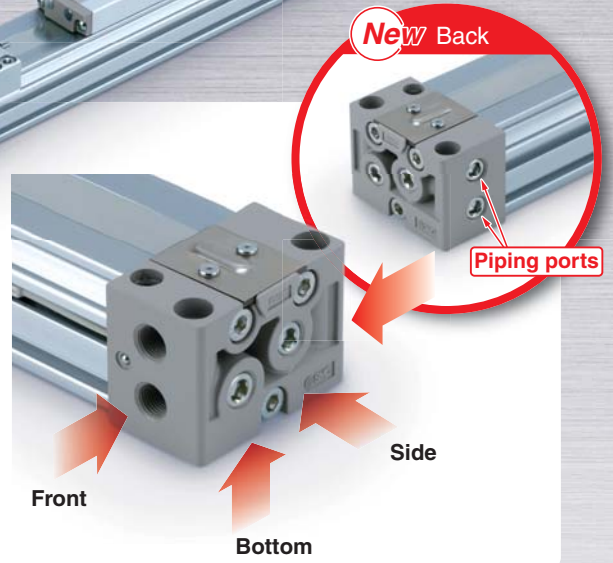

New Easy adjustment of cushion needle

Adjustment is easier by changing the cushion needle adjustment from side to top.

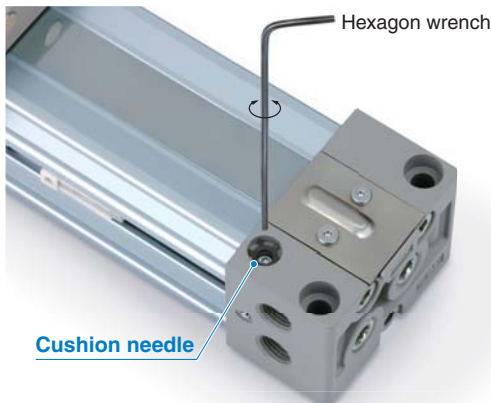

Auto switch can be mounted in any desired position. (D-M9□, D-A9□)

Auto switches can be mounted from the front at any position on the mounting groove. Contributes to reduction in mounting time.

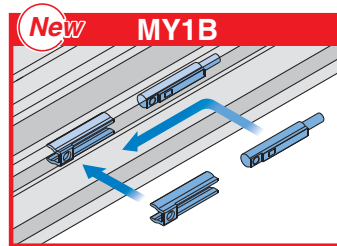

Front mounting

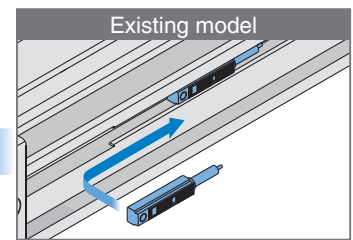

Insert it at the notch and slide it along the mounting groove.

Series MY1B



CAT.EUS20-210Aa-UK

Series MY1B

Improvement of port variations

With addition of the back port, piping can be connected to suit the installation conditions.

Standard piping type

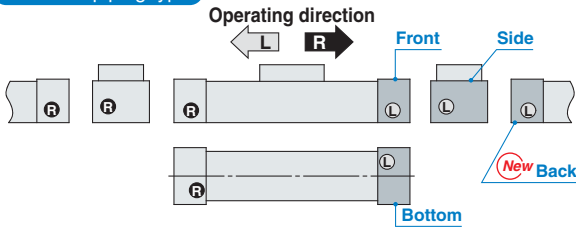

Centralised piping type

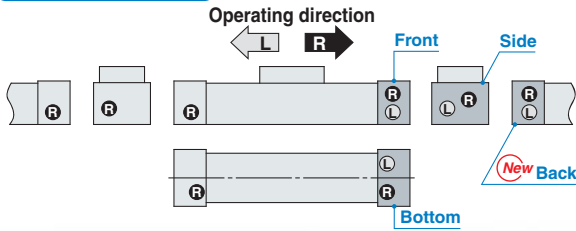

New dust seal band improves life.

Retention mechanism of the dust seal band is changed to the magnet attraction method to improve the retention ability.

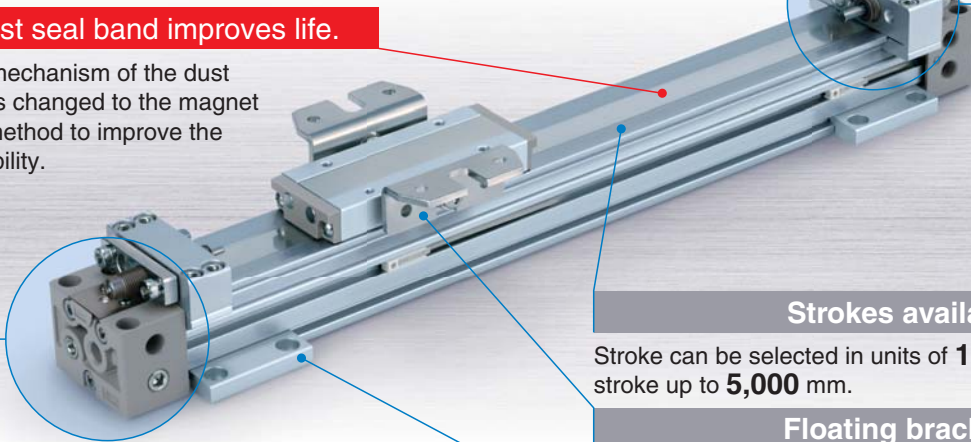

Stroke adjustment unit

The stroke can be adjusted at one side and both sides.

- With adjustment bolt
- With low/high load shock absorber + adjustment bolt (L/H unit)

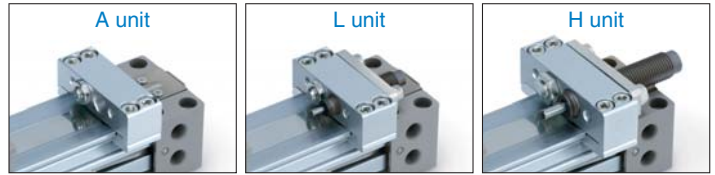

Intermediate fixing spacer as standard

Fixture can be selected to hold the stroke adjustment unit at the intermediate stroke position.

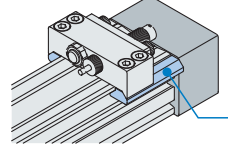

Improved shock-less characteristics when a work piece is stopped.

Soft type of shock absorber can be selected for the stroke adjustment unit. (Made to Order: -XB22)

The cross section of the liquid passage is changed in proportion to the stroke by a unique mechanism. This allows a smooth absorption process.

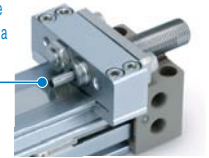

Strokes available

Stroke can be selected in units of 1 mm. Available with a stroke up to 5,000 mm.

Floating bracket

2 connection types can be selected. Easier to connect to other guide types.



Side support

Prevents deflection of the cylinder tube at a long stroke.

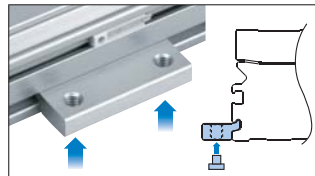
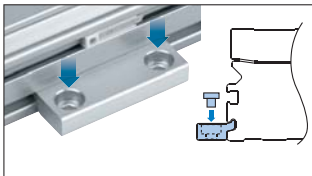

MY1 Series Variations

Series	Bore size [mm]										Page	
	10	16	20	25	32	40	50	63	80	100		
New MY1B				●	●	●						Page 5 of this catalogue Digital Catalogue Digital catalogue www.smc.eu
MY1B	●	●	●				●	●	●	●		
MY1M		●	●	●	●	●	●	●				
MY1C		●	●	●	●	●	●	●				
MY1H	●	●	●	●	●	●	●	●				
MY1H End lock		●	●	●	●	●	●	●				
MY1HT							●	●				
MY1□W		●	●	●	●	●	●	●				

Series MY1B

Prior to Use 1

Maximum Allowable Moment/Maximum Load Weight

Model	Bore size [mm]	Maximum allowable moment [N·m]			Maximum load weight [kg]		
		M ₁	M ₂	M ₃	m ₁	m ₂	m ₃
MY1B	25	10	1.2	3.0	29	5.8	5.4
	32	20	2.4	6.0	40	8.0	8.8
	40	40	4.8	12	53	10.6	14

The above values are the maximum allowable values for moment and load weight. Refer to each graph regarding the maximum allowable moment and maximum load weight for a particular piston speed.

Load weight [kg]

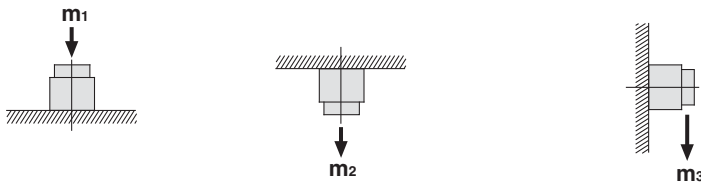

Moment [N·m]

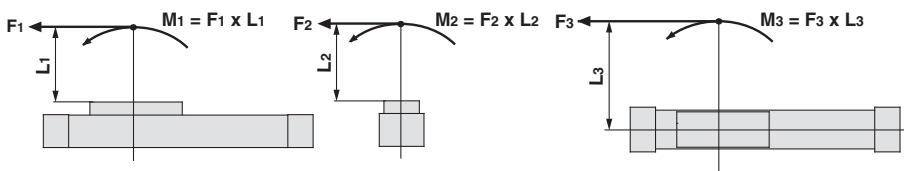

Caution on Design

1. We recommend an external shock absorber be installed when the cylinder is combined with another guide (connection with floating bracket, etc.) and the maximum load weight is exceeded.

2. Load factor of 0.5 or less

When the load factor is high against the cylinder output, it may adversely affect the cylinder (condensation, etc.) and cause malfunctions. Select a cylinder to make the load factor 0.5 or less. (Mainly when using an external guide)

When using it as a load balancer, please contact SMC sales representatives.

3. Consider uncalculated loads such as piping, cableveyor, etc., when selecting a load moment

Calculation does not include the external acting force of piping, cableveyor, etc. Select load factors taking into account the external acting force of piping, cableveyor, etc.

4. Accuracy

Mechanically jointed rodless cylinders do not guarantee traveling parallelism. When accuracy in traveling parallelism and intermediate stroke position is required, please contact SMC sales representatives.

Calculation of Guide Load Factor

1) Maximum load weight (1), static moment (2), and dynamic moment (3) (at the time of impact with stopper) must be examined for the selection calculations.

* To evaluate, use \bar{v}_a (average speed) for (1) and (2), and v (collision speed $v = 1.4\bar{v}_a$) for (3). Calculate m_{max} for (1) from the maximum load weight graph (m_1, m_2, m_3) and M_{max} for (2) and (3) from the maximum allowable moment graph (M_1, M_2, M_3).

$$\text{Sum of guide load factors } \Sigma\alpha = \frac{\text{Load weight [m]}}{\text{Maximum load weight [m max]}} + \frac{\text{Static moment [M]}^{\text{Note 1)}}}{\text{Allowable static moment [M max]}} + \frac{\text{Dynamic moment [ME]}^{\text{Note 2)}}}{\text{Allowable dynamic moment [ME max]}} \leq 1$$

Note 1) Moment caused by the load, etc., with cylinder in resting condition

Note 2) Moment caused by the load equivalent to impact at the stroke end (at the time of impact with stopper)

Note 3) Depending on the shape of a workpiece, multiple moments may occur. When this happens, the sum of the load factors ($\Sigma\alpha$) is the total of all such moments.

2) Reference formula [Dynamic moment at the time of impact]

Use the following formulae to calculate dynamic moment when taking stopper impact into consideration.

- m** : Load weight [kg]
- F** : Load [N]
- F_E** : Load equivalent to impact (at the time of impact with stopper) [N]
- \bar{v}_a** : Average speed [mm/s]
- M** : Static moment [N·m]
- v** : Collision speed [mm/s]
- L₁** : Distance to the load center of gravity [M]
- ME** : Dynamic moment [N·m]
- δ** : Bumper coefficient
With air cushion = 1/100
With shock absorber = 1/100
- g** : Gravitational acceleration (9.8 m/s²)

$$v = 1.4\bar{v}_a \text{ [mm/s]} \quad F_E = 1.4\bar{v}_a \cdot \delta \cdot m \cdot g$$

$$\therefore ME = \frac{1}{3} \cdot F_E \cdot L_1 = 4.57\bar{v}_a \delta m L_1 \text{ [N·m]}$$

Note 4) $1.4\bar{v}_a \delta$ is a dimensionless coefficient for calculating impact force.

Note 5) Average load coefficient ($= \frac{1}{3}$): For averaging the maximum load moment at the time of impact with stopper according to service life calculations.

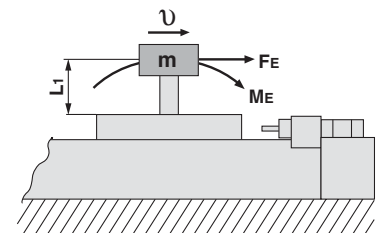

3) For detailed selection procedures, refer to page 3.

Series MY1B

Prior to Use 2

Maximum Allowable Moment/Maximum Load Weight

Maximum Allowable Moment

Select the moment from within the range of operating limits shown in the graphs. Note that the maximum load weight value may sometimes be exceeded even within the operating limits shown in the graphs. Therefore, also check the load weight for the selected

MY1B/M₁

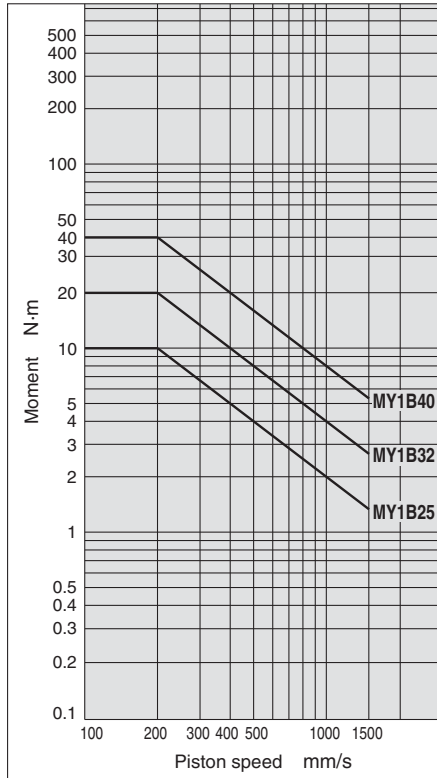

MY1B/M₂

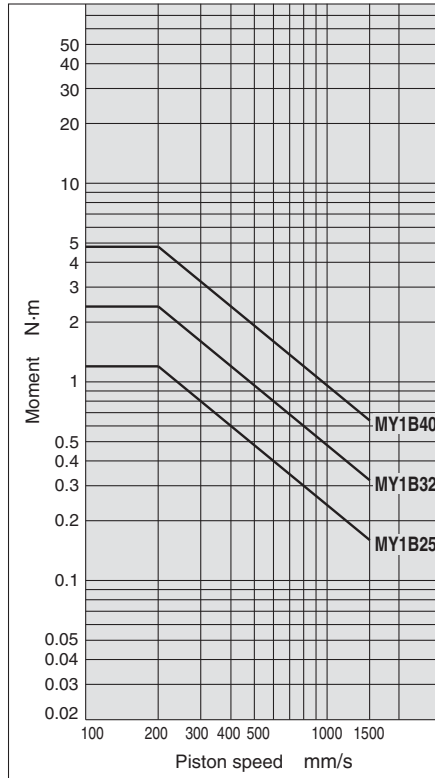

MY1B/M₃

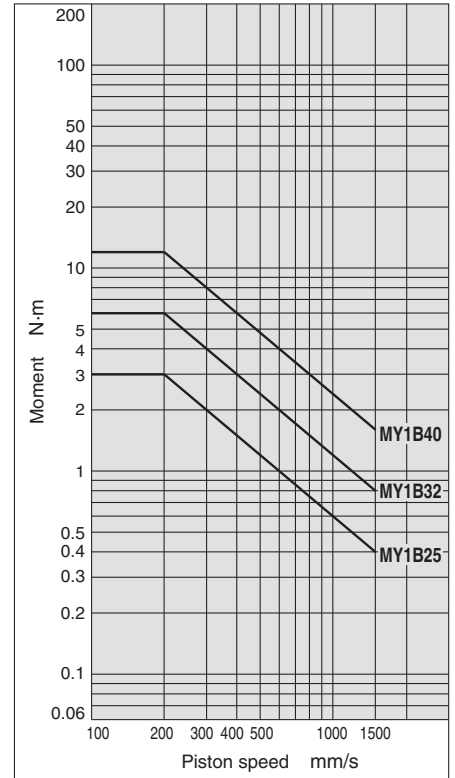

Maximum Load Weight

Select the load weight from within the range of limits shown in the graphs. Note that the maximum allowable moment value may sometimes be exceeded even within the operating limits shown in the graphs. Therefore, also check the allowable moment for the selected conditions.

MY1B/m₁

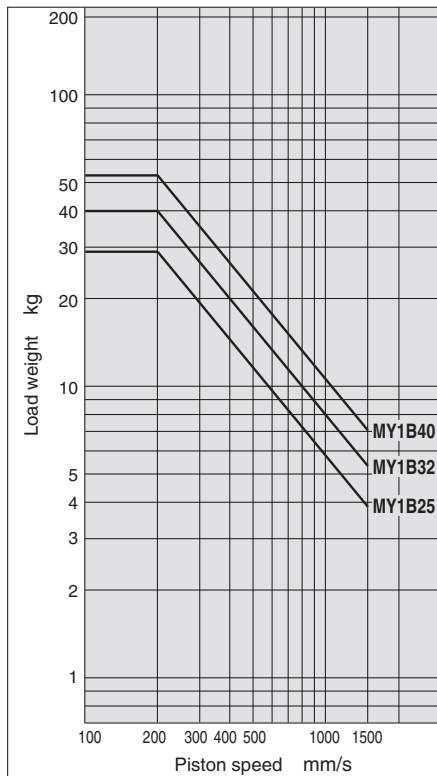

MY1B/m₂

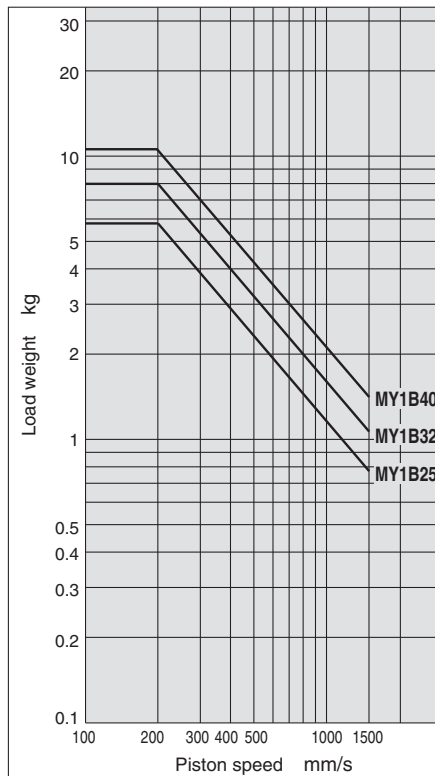

MY1B/m₃

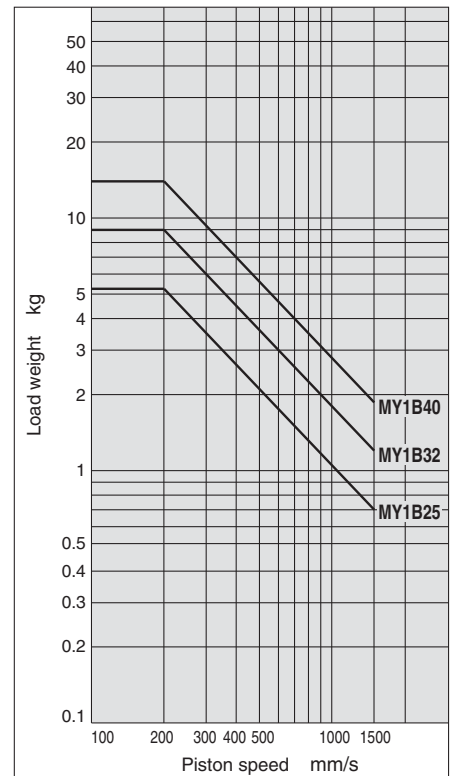

Series MY1B Model Selection

The following is the steps for selecting the most suitable MY1B series to your application.

Calculation of Guide Load Factor

1 Operating Conditions

Cylinder MY1B32-500Z W: Work piece (2 kg)
 Average operating speed v_a 300 mm/s
 Mounting orientation ... Horizontal mounting
 Cushion Air cushion ($\delta = 1/100$)

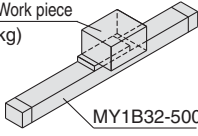

Mounting Orientation

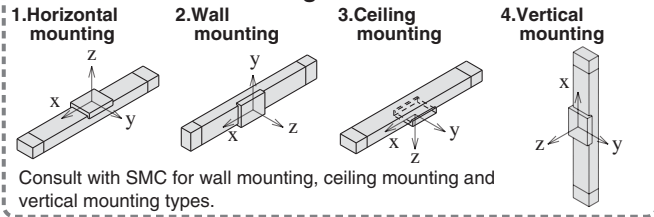

Consult with SMC for wall mounting, ceiling mounting and vertical mounting types.

2 Load Blocking

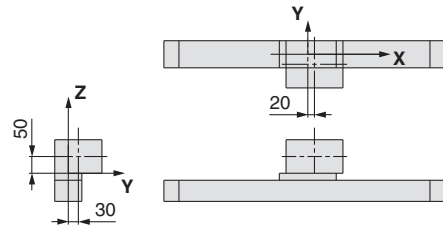

Work Piece Weight and Centre of Gravity

Work piece	Weight m	Centre of gravity		
		X-axis	Y-axis	Z-axis
W	2 kg	20 mm	30 mm	50 mm

3 Calculation of Load Factor for Static Load

• m_1 : Weight

m_1 max (from ① of graph MY1B/ m_1) = 27 [kg] m_1
 Load factor $\alpha_1 = m_1/m_1 \text{ max} = 2/27 = 0.07$

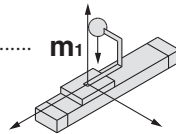

• M_1 : Moment

M_1 max (from ② of graph MY1B/ M_1) = 13 [N-m] M_1
 $M_1 = m_1 \times g \times X = 2 \times 9.8 \times 20 \times 10^{-3} = 0.39$ [N-m]
 Load factor $\alpha_2 = M_1/M_1 \text{ max} = 0.39/13 = 0.03$

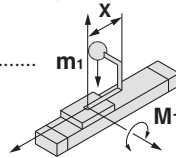

• M_2 : Moment

M_2 max (from ③ of graph MY1B/ M_2) = 1.6 [N-m] M_2
 $M_2 = m_1 \times g \times Y = 2 \times 9.8 \times 30 \times 10^{-3} = 0.59$ [N-m]
 Load factor $\alpha_3 = M_2/M_2 \text{ max} = 0.59/1.6 = 0.37$

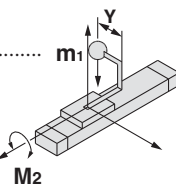

4 Calculation of Load Factor for Dynamic Moment

Equivalent load F_E at impact

$$F_E = 1.4v_a \times \delta \times m \times g = 1.4 \times 300 \times \frac{1}{100} \times 2 \times 9.8 = 82.3 \text{ [N]}$$

• M_{1E} : Moment

M_{1E} max (from ① of graph MY1B/ M_1 where $1.4v_a = 420$ mm/s) = 9.5 [N-m] M_{1E}
 $M_{1E} = \frac{1}{3} \times F_E \times Z = \frac{1}{3} \times 82.3 \times 50 \times 10^{-3}$
 $= 1.37$ [N-m]
 Load factor $\alpha_4 = M_{1E}/M_{1E} \text{ max} = 1.37/9.5 = 0.14$

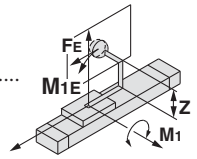

• M_{3E} : Moment

M_{3E} max (from ⑤ of graph MY1B/ M_3 where $1.4v_a = 420$ mm/s) = 2.9 [N-m] M_{3E}
 $M_{3E} = \frac{1}{3} \times F_E \times Y = \frac{1}{3} \times 82.3 \times 30 \times 10^{-3}$
 $= 0.82$ [N-m]
 Load factor $\alpha_5 = M_{3E}/M_{3E} \text{ max} = 0.82/2.9 = 0.28$

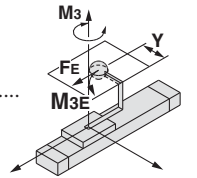

5 Sum and Examination of Guide Load Factors

$$\Sigma\alpha = \alpha_1 + \alpha_2 + \alpha_3 + \alpha_4 + \alpha_5 = 0.89 \leq 1$$

The above calculation is within the allowable value, and therefore the selected model can be used. Select a shock absorber separately. In an actual calculation, when the total sum of guide load factors $\Sigma\alpha$ in the formula above is over 1, consider either decreasing the speed, increasing the bore size, or changing the product series. This calculation can be easily made using the "Guide Cylinder Selection Software", download it from <http://www.smc.eu>

Load Weight

MY1B/ m_1

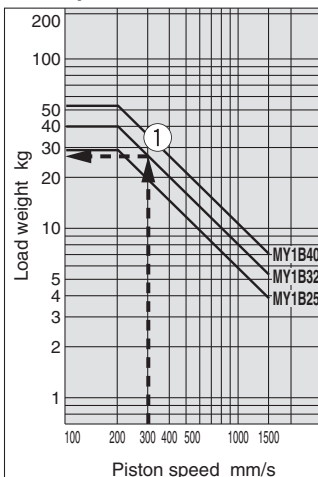

Allowable Moment

MY1B/ M_1

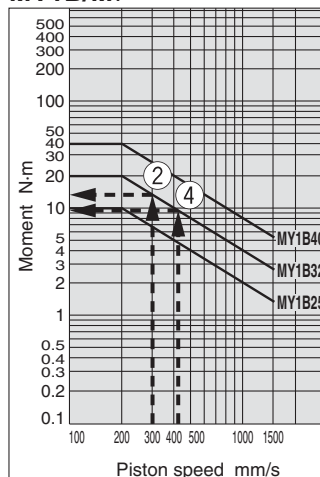

MY1B/ M_2

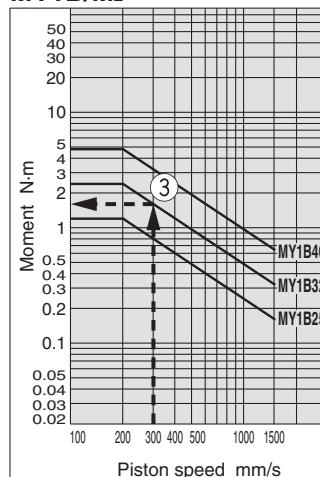

MY1B/ M_3

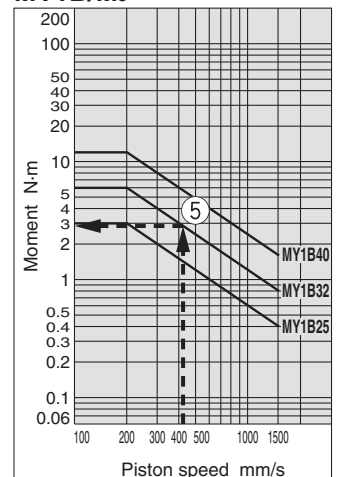



Series MY1B

Specific Product Precautions

Be sure to read the below before handling. Refer to back cover for Safety Instructions. For Actuator and Auto Switch Precautions, refer to "Handling Precautions for SMC Products" (M-E03-3) and Operation Manual.

The Operation Manual can be downloaded from the SMC website, <http://www.smcworld.com>

Selection

⚠ Caution

1. When using a cylinder with long strokes, implement an intermediate support.

When using a cylinder with long strokes, implement an intermediate support to prevent the tube from sagging and being deflected by vibration or an external load.

Refer to the "Guide to Side Support Application" on page 12.

2. For intermediate stops, use a dual-side pressure control circuit.

Since the mechanically jointed rodless cylinders have a unique seal structure, slight external leakage may occur. Controlling intermediate stops with a 3-position valve cannot hold the stopping position of the slide table (slider). The speed at the restarting state also may not be controllable. Use the dual-side pressure control circuit with a PAB-connected 3-position valve for intermediate stops.

3. Cautions on less frequent operation

When the cylinder is used extremely infrequently, operation may be interrupted in order for anchoring and a change lubrication to be performed or service life may be reduced.

Mounting

⚠ Caution

1. Do not apply strong impacts or excessive moment to the slide table (slider).

- Do not apply strong impacts or excessive moment, etc., when mounting workpieces.

2. Do not mount cylinders as they are twisted.

When mounting, be sure for a cylinder tube not to be twisted. The flatness of the mounting surface is not appropriate, the cylinder tube is twisted, which may cause air leakage due to the detachment of a seal belt, damage a dust seal band, and cause malfunctions.

3. Do not mount a slide table on the fixed equipment surface.

It may cause damage or malfunctions since an excessive load is applied to the bearing.

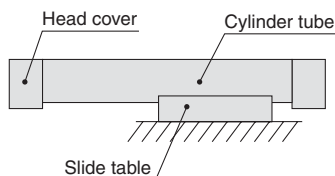

Mounting with a slide table (slider)

4. Consult SMC when mounting in a cantilevered way.

Since the cylinder body deflects, it may cause malfunctions. When using it this way, please contact SMC sales representatives.

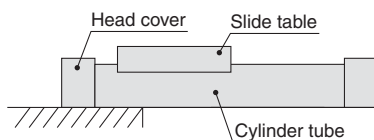

Mounting in a cantilevered way

Mounting

⚠ Caution

5. Fixed parts of the cylinder on both ends must have at least 5 mm of contact between where the bottom of the cylinder tube and the equipment surface.

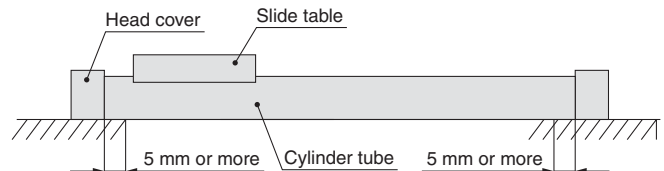

6. Do not generate negative pressure in the cylinder tube.

Take precautions under operating conditions in which negative pressure is generated inside the cylinder by external forces or inertial forces. Air leakage may occur due to separation of the seal belt. Do not generate negative pressure in the cylinder by forcibly moving it with an external force during the trial operation or dropping it with its own weight under the non-pressure state, etc. When the negative pressure is generated, slowly move the cylinder by hand and move the stroke back and forth. After doing so, if air leakage still occurs, please contact SMC sales representatives.

Operating Environment

⚠ Warning

1. Do not use in an environment where the cylinder is exposed to coolant, cutting oil, water drops, adhesive foreign matter, dust, etc. and avoid use with compressed air containing drainage and foreign matter.

- Foreign matter or liquids on the cylinder's interior or exterior can wash out the lubricating grease, which can lead to deterioration and damage of dust seal band and seal materials, causing a danger of malfunction.

When operating in locations with exposure to water and oil, or in dusty locations, provide protection such as a cover to prevent direct contact with the cylinder, or mount so that the dust seal band surface faces downward, and operate with clean compressed air.

2. Carry out cleaning and grease application suitable for the operating environment.

Carry out cleaning regularly when using in an operating environment in which the product is likely to get dirty.

After cleaning, be sure to apply grease to the top side of the cylinder tube and the rotating part of the dust seal band. Apply grease to these parts regularly even if not after cleaning. For cleaning of the slide table (slider) interior and grease application, please contact SMC sales representatives.

3. This product is not designed to be used in a clean room.

If you are considering using it in a clean room, please contact SMC sales representatives.

Mechanically Jointed Rodless Cylinder Basic Type

Series **MY1B**

∅25, ∅32, ∅40



How to Order

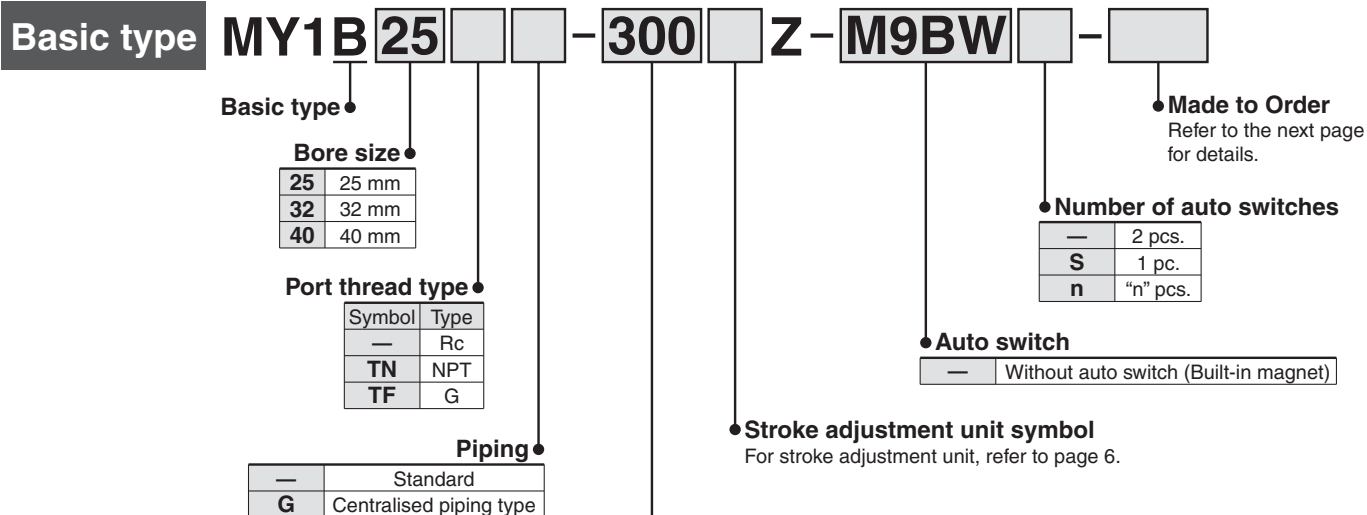

Bore size [mm]	Standard stroke [mm]*	Maximum manufacturable stroke [mm]
25, 32, 40	100,200,300,400,500,600 700,800,900,1000,1200 1400,1600,1800,2000	5000

* Strokes are manufacturable in 1 mm increments, up to the maximum stroke. However, please be advised that with stroke 49 or less, there are cases where auto switch mounting is not possible and the performance of the air cushion may decline. Also when exceeding a 2000 mm stroke, specify "-XB11" at the end of the part number. For details, refer to the Made-to-Order specifications.

Applicable Auto Switches/Refer to Auto Switch guide for further information on auto switches.

Type	Special function	Electrical entry	Indicator/light	Wiring (Output)	Load voltage		Auto switch model		Lead wire length [m]				Pre-wired connector	Applicable load					
					DC	AC	Perpendicular	In-line	0.5 (—)	1 (M)	3 (L)	5 (Z)							
Solid state auto switch	—	Grommet	Yes	3-wire (NPN)	24 V	5 V, 12 V	—	M9NV	M9N	●	●	●	○	○	IC circuit	Relay, PLC			
				3-wire (PNP)				M9PV	M9P	●	●	●	○	○					
				2-wire				M9BV	M9B	●	●	●	○	○					
	Diagnostic indication (2-colour indication)			3-wire (NPN)	5 V, 12 V	—	M9NWV	M9NW	●	●	●	○	○	IC circuit					
				3-wire (PNP)			M9PWV	M9PW	●	●	●	○	○						
				2-wire			M9BWV	M9BW	●	●	●	○	○						
	Water resistant (2-colour indication)			3-wire (NPN)	5 V, 12 V	—	M9NAV**	M9NA**	○	○	●	○	○	IC circuit					
				3-wire (PNP)			M9PAV**	M9PA**	○	○	●	○	○						
				2-wire			M9BAV**	M9BA**	○	○	●	○	○						
Reed auto switch	—	Grommet	Yes	3-wire (NPN equivalent)	24 V	5 V	—	A96V	A96	●	—	●	—	—	IC circuit	—			
				2-wire				100 V	A93V	A93	●	—	●	●			—	—	Relay, PLC
								100 V or less	A90V	A90	●	—	●	—			—		

** Water resistant type auto switches can be mounted on the above models, but in such case SMC cannot guarantee water resistance. Consult with SMC regarding water resistant types with the above model numbers.

* Lead wire length symbols: 0.5 m — (Example) M9NW * Solid state auto switches marked with "○" are produced upon receipt of order.
 1 m M (Example) M9NWM
 3 m L (Example) M9NWL
 5 m Z (Example) M9NWZ

* There are other applicable auto switches other than the listed above. For details, refer to page 14.

* For details about auto switches with pre-wired connector, refer to Auto Switch guide.

* Auto switches are shipped together, (but not assembled).

Series MY1B

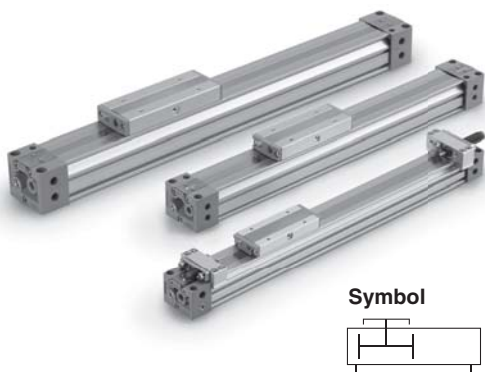

Symbol

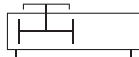

Made to Order
(For details, refer to pages 16 and 17.)

Symbol	Specifications
-XB11	Long stroke
-XB22	Shock absorber/ soft type RJ series mounted
-X168	Helical insert thread

Stroke Adjustment Unit Specifications

Bore size [mm]		25			32			40		
Unit symbol		A	L	H	A	L	H	A	L	H
Stroke adjustment range by intermediate fixing spacer [mm]	Without Spacer	0 to -11.5			0 to -12			0 to -16		
	With short spacer	-11.5 to -23			-12 to -24			-16 to -32		
	With long spacer	-23 to -34.5			-24 to -36			-32 to -48		

* Stroke adjustment range is applicable for one side when mounted on a cylinder.

Stroke Adjustment Unit Symbol

		Right side stroke adjustment unit									
		Without unit	A: With adjustment bolt			L: With low load shock absorber + Adjustment bolt			H: With high load shock absorber + Adjustment bolt		
Left side stroke adjustment unit	Without unit	—	SA	SA6	SA7	SL	SL6	SL7	SH	SH6	SH7
	A: With adjustment bolt	AS	A	AA6	AA7	AL	AL6	AL7	AH	AH6	AH7
With short spacer		A6S	A6A	A6	A6A7	A6L	A6L6	A6L7	A6H	A6H6	A6H7
L: With low load shock absorber + Adjustment bolt	With long spacer	A7S	A7A	A7A6	A7	A7L	A7L6	A7L7	A7H	A7H6	A7H7
	LS	LA	LA6	LA7	L	LL6	LL7	LH	LH6	LH7	
H: With high load shock absorber + Adjustment bolt	With short spacer	L6S	L6A	L6A6	L6A7	L6L	L6L6	L6L7	L6H	L6H6	L6H7
	With long spacer	L7S	L7A	L7A6	L7A7	L7L	L7L6	L7L7	L7H	L7H6	L7H7
H: With high load shock absorber + Adjustment bolt	HS	HA	HA6	HA7	HL	HL6	HL7	H	HH6	HH7	
	With short spacer	H6S	H6A	H6A6	H6A7	H6L	H6L6	H6L7	H6H	H6H6	H6H7
H: With high load shock absorber + Adjustment bolt	With long spacer	H7S	H7A	H7A6	H7A7	H7L	H7L6	H7L7	H7H	H7H6	H7H7

* Spacers are used to fix the stroke adjustment unit an intermediate stroke position

Shock Absorber Model for L and H Units

Type	Stroke adjustment unit	Bore size [mm]		
		25	32	40
Standard	L	RB1007	RB1412	
	H	RB1412	RB2015	
Shock absorber/ soft type (-XB22)	L	RJ1007H	RJ1412H	
	H	RJ1412H	—	—

Shock Absorber Specifications

Model	RB1007	RB1412	RB2015	
Max. energy absorption [J]	5.9	19.6	58.8	
Stroke absorption [mm]	7	12	15	
Max. collision speed [mm/s]	1500	1500	1500	
Max. operating frequency [cycle/min]	70	45	25	
Spring force [N]	Extended	4.22	6.86	8.34
	Retracted	6.86	15.98	20.50
Operating temperature range [°C]	5 to 60			

Note) The shock absorber service life is different from that of the MY1B cylinder depending on the operating conditions. Allowable operating cycles under the specifications prescribed in our catalogue are shown below.

1.2 million cycles RB0806
2 million cycles RB1007 to RB2015

Note) Specified service life (suitable replacement period) is the value at room temperature (20 to 25°C). The period may vary depending on the temperature and other conditions. In some cases the absorber may need to be replaced before the allowable operating cycles above.

Specifications

Bore size [mm]		25	32	40
Fluid		Air		
Action		Double acting		
Operating pressure range		0.1 to 0.8 MPa		
Proof pressure		1.2 MPa		
Ambient and fluid temperature		5 to 60°C		
Cushion		Air cushion		
Lubrication		Non-lube		
Stroke length tolerance		2700 or less ^{+1.8} ₀ ; 2701 to 5000 ^{+2.8} ₀		
Piping port size	Front/Side/Back port	Rc1/8		
	Bottom port	ø5	ø6	ø8

Piston Speed

Bore size [mm]		25 to 40
Without stroke adjustment unit		100 to 1000 mm/s
Stroke adjustment unit	A unit	100 to 1000 mm/s (Note 1)
	L unit, H unit	100 to 1500 mm/s (Note 2)

Note 1) Be aware that when the stroke adjustment range is increased with the adjustment bolt, the air cushion capacity decreases. Also, when exceeding the air cushion stroke ranges on page 8, the piston speed should be 100 to 200 mm/s.

Note 2) The piston speed is 100 to 1000 mm/s for centralised piping.

Note 3) Use at a speed within the absorption capacity range. Refer to page 8.

Note 4) Due to the construction of this product, it may have more fluctuation in operating speed compared to a rod type air cylinder. For applications that require constant speed, select the equipment corresponding to the required level.

Stroke adjustment unit mounting diagram

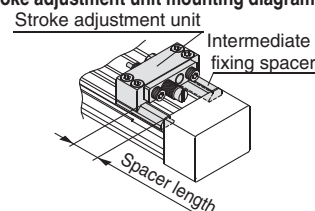

Example of H6H7 attachment

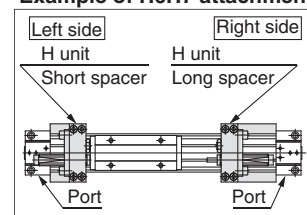

Theoretical Output

Unit: N

Bore size [mm]	Piston area [mm ²]	Operating pressure [MPa]						
		0.2	0.3	0.4	0.5	0.6	0.7	0.8
25	490	98	147	196	245	294	343	392
32	804	161	241	322	402	483	563	643
40	1256	251	377	502	628	754	879	1005

Note) Theoretical output [N] = Pressure [MPa] x Piston area [mm²]

Weight

Unit: kg

Bore size [mm]	Basic weight	Additional weight per 50 mm of stroke	Side support weight (per set)	Stroke adjustment unit weight (per unit)		
			A/B type weight	A unit weight	L unit weight	H unit weight
25	1.14	0.11	0.02	0.06	0.10	0.18
32	2.28	0.17	0.02	0.12	0.21	0.40
40	3.11	0.25	0.04	0.23	0.32	0.49

Calculation: (Example) **MY1B25-300AZ**

Basic weight 1.14 kg
 Cylinder stroke 300 mm stroke
 Additional weight 0.11 kg/50 mm stroke
 A unit weight 0.06 kg
 1.14 + 0.11 x 300 ÷ 50 + 0.06 x 2 ≈ 1.92 kg

Options

Stroke Adjustment Unit/Part No.

MY - A 25 L2 - 6N

Stroke adjustment unit

● Bore size

25	25 mm
32	32 mm
40	40 mm

Unit no.

Symbol	Stroke adjustment unit	Mounting position
A1	A unit	Left
A2	A unit	Right
L1	L unit	Left
L2	L unit	Right
H1	H unit	Left
H2	H unit	Right

Note) For details about adjustment range, refer to page. 6.

Intermediate fixing spacer

—	Without Spacer
6	Short spacer
7	Long spacer

Spacer delivery style

—	Unit installed
N	Spacer only

*Spacers are used to fix the stroke adjustment unit at an intermediate stroke position.
 *Spacers are shipped for a set of two.

Stroke adjustment unit
Intermediate fixing spacer
Spacer length

Component Parts

MY-A25L2 Without Spacer	MY-A25L2-6 With short spacer	MY-A25L2-7 With long spacer	MY-A25L2-6N Short spacer only
	Short spacer	Long spacer	Short spacer
			MY-A25L2-7N Long spacer only
			Long spacer

Side Support/Part No.

Type	Bore size [mm]	25	32	40
Side support A		MY-S25A	MY-S32A	MY-S32A
Side support B		MY-S25B	MY-S32B	MY-S32B

For details about the dimensions, etc., refer to page 12.
 Side supports consist of a set of right and left supports.

Series MY1B

Cushion Capacity

Cushion Selection

<Air cushion>

Air cushions are a standard feature on mechanically jointed rodless cylinders.

The air cushion mechanism is incorporated to prevent excessive impact of the piston with high kinetic energy at the stroke end. The purpose of air cushion, thus, is not to decelerate the piston near the stroke end.

The ranges of load and speed that air cushions can absorb are within the air cushion limit lines shown in the graphs.

<Stroke adjustment unit with shock absorber>

Use this unit when operating with a load and speed exceeding the air cushion limit line, or when cushioning is required outside of the effective air cushion stroke range due to stroke adjustment.

L unit

Use this unit when cushioning is necessary outside of the effective air cushion range even if the load and speed are within the air cushion limit line, or when the cylinder is operated in a load and speed range above the air cushion limit line and below the L unit limit line.

H unit

Use this unit when the cylinder is operated in a load and speed range above the L unit limit line and below the H unit limit line.

<Fastening of unit>

The unit can be secured by evenly tightening the four unit holding bolts.

<Stroke adjustment with adjustment bolt>

Loosen the adjustment bolt lock nut, and adjust the stroke from the lock plate side using a hexagon wrench. Retighten the lock nut.

<Stroke adjustment with shock absorber>

Loosen the two lock plate holding bolts, turn the shock absorber and adjust the stroke. Then, uniformly tighten the lock plate holding bolts to secure the shock absorber.

Take care not to over-tighten the holding bolts. (Refer to the "Tightening Torque for Stroke Adjustment Unit Lock Plate Holding Bolts.")

(Note)

Although the lock plate may slightly bend due to tightening of the lock plate holding bolt, this does not affect the shock absorber and locking function.

Absorption Capacity of Air Cushion and Stroke Adjustment Units

MY1B25 Horizontal collision: P = 0.5 MPa

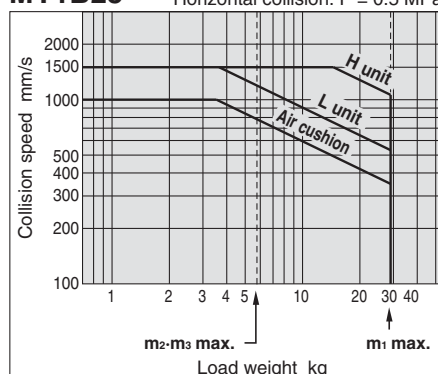

MY1B32 Horizontal collision: P = 0.5 MPa

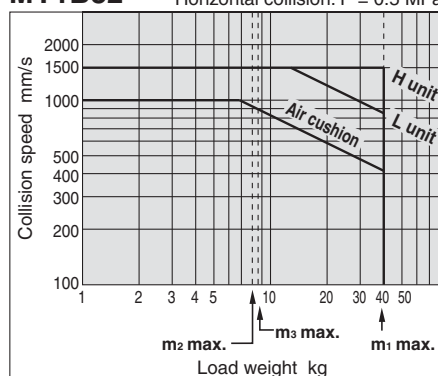

MY1B40 Horizontal collision: P = 0.5 MPa

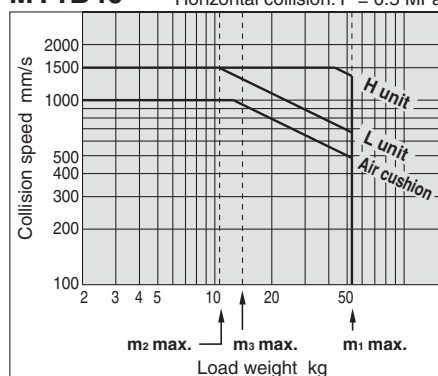

Air Cushion Stroke

Unit: mm

Bore size [mm]	Cushion stroke
25	15
32	19
40	24

Tightening Torque for Stroke Adjustment Unit Holding Bolts

Unit: N·m

Bore size [mm]	Unit	Tightening torque
25	A	3.5
	L	
	H	
32	A	5.8
	L	
	H	
40	A	13.8
	L	
	H	

Tightening Torque for Stroke Adjustment Unit Lock Plate Holding Bolts

Unit: N·m

Bore size [mm]	Unit	Tightening torque
25	L	1.2
	H	3.3
32	L	3.3
	H	10
40	L	3.3
	H	10

Calculation of Absorbed Energy for Stroke Adjustment Unit with Shock Absorber

Unit: N·m

Type of impact	Horizontal collision	Vertical collision (Downward)	Vertical collision (Upward)
Kinetic energy E ₁	$\frac{1}{2} m \cdot v^2$		
Thrust energy E ₂	F·s	F·s + m·g·s	F·s - m·g·s
Absorbed energy E	E ₁ + E ₂		

Symbols

v: Speed of impact object [m/s]

F: Cylinder thrust [N]

s: Shock absorber stroke [m]

m: Weight of impact object [kg]

g: Gravitational acceleration [9.8 m/s²]

(Note) The speed of the impact object is measured at the time of impact with the shock absorber.

⚠ Caution

1. Use caution not to get your hands caught in the unit.

- When using a product with stroke adjustment unit, the space between the slide table (slider) and the stroke adjustment unit becomes narrow at the stroke end, causing a danger of hands getting caught. Install a protective cover to prevent direct contact with the human body.

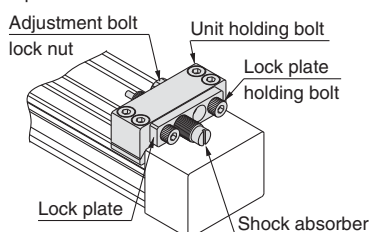

2. Do not operate with the stroke adjustment unit fixed in an intermediate position.

When the stroke adjustment unit is fixed in an intermediate position, slippage can occur depending on the amount of energy released at the time of an impact. In such cases, the use of the holder mounting brackets for adjustment, available per made-to-order "-X416" and "-X417", is recommended.

For other lengths, please consult with SMC. (Refer to the "Tightening Torque for Stroke Adjustment Unit Holding Bolts.")

3. Refer to the below figure when using the adjustment bolt to perform stroke adjustment.

When the effective stroke of the shock absorber decreases as a result of stroke adjustment, the absorption capacity decreases dramatically. Secure the adjustment bolt at the position where it protrudes approximately 0.5 mm from the shock absorber.

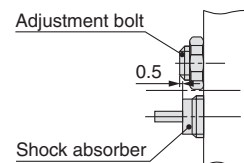

4. Do not use a shock absorber together with air cushion.

Mechanically Jointed Rodless Cylinder Basic Type **Series MY1B**

Construction $\varnothing 25, \varnothing 32, \varnothing 40$

MY1B25 to 40

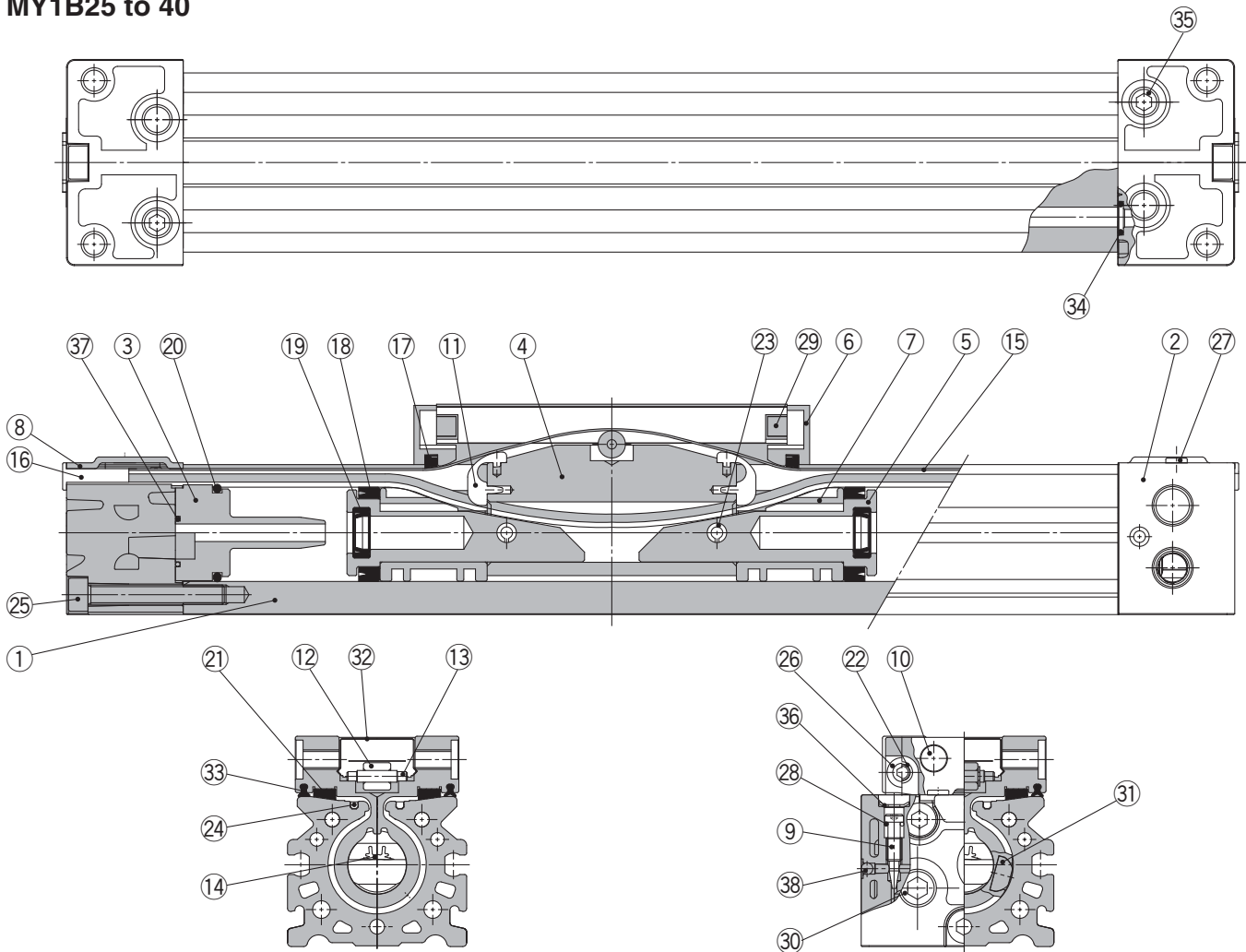

Component Parts

No.	Description	Material	Qty.	Note
1	Cylinder tube	Aluminium alloy	1	Hard anodised
2	Head cover	Aluminium alloy	2	Painted
3	Cushion boss	Polyacetal	2	
4	Piston yoke	Aluminium alloy	1	Anodised
5	Piston	Aluminium alloy	2	Chromated
6	End cover	Polyacetal	2	
7	Wear ring	Polyacetal	2	
8	Head plate	Stainless steel	2	
9	Cushion needle	Rolled steel	2	Nickel plated
10	Stopper	Carbon steel	4	Nickel plated
11	Belt separator	Polyacetal	2	
12	Guide roller	Polyacetal	1	
13	Parallel pin	Carbon steel	1	
16	Belt clamp	Polybutylene terephthalate	2	
21	Bearing	Polyacetal	2	

No.	Description	Material	Qty.	Note
22	Spacer	Stainless steel	4	
23	Spring pin	Carbon tool steel	2	
24	Seal magnet	Rubber magnet	2	
25	Hexagon socket head cap screw	Chromium molybdenum steel	6	Chromated
26	Hexagon socket button head screw	Chromium molybdenum steel	4	Chromated
27	Thin head screw	Chromium molybdenum steel	4	Chromated
29	Double round parallel key	Carbon steel	2	
30	Hexagon socket head taper plug	Carbon steel	4	Chromated (Centralised piping: 7pcs.)
31	Magnet	Rare earth magnet	2	
32	Top cover	Stainless steel	1	
35	Hexagon socket head taper plug	Carbon steel	2	Chromated (Centralised piping: 3 pcs.)
36	Type CR retaining ring	Spring steel	2	
38	Steel ball	Spring steel	2	

Seal List

No.	Description	Material	Qty.	MY1B25	MY1B32	MY1B40
14	Seal belt	Polyamide	1	MY25-16C-[Stroke]	MY32-16C-[Stroke]	MY40-16A-[Stroke]
15	Dust seal band	Stainless steel	1	MY1B25-16B-[Stroke]	MY1B32-16B-[Stroke]	MY1B40-16B-[Stroke]
33	Side scraper	Polyamide	2	MYB25-15BA5900B	MYB32-15BA5901B	MYB40-15BA5902B
28	O-ring	NBR	2	$\varnothing 5.1 \times \varnothing 3 \times \varnothing 1.05$	$\varnothing 7.15 \times \varnothing 3.75 \times \varnothing 1.7$	$\varnothing 7.15 \times \varnothing 3.75 \times \varnothing 1.7$
37	Cushion boss gasket	NBR	2	MYB25-16GA5900	MYB32-16GA5901	MYB40-16GA5902
17	Scraper	NBR	2	MY1B25-PS	MY1B32-PS	MY1B40-PS
18	Piston seal	NBR	2			
19	Cushion seal	NBR	2			
20	Tube gasket	NBR	2			
34	O-ring	NBR	2			

* Seal kit includes 17, 18, 19, 20 and 34.
Order the seal kit based on each bore size.

* Seal kit includes a grease pack (10 g).
When 14 and 15 are shipped independently, a grease pack is included. (10 g/1000 mm stroke)
Order with the following part number when only the grease pack is needed.
Grease pack part number:
GR-S-010 (10 g), GR-S-020 (20 g)

Note) For the replacement procedure of replacement parts/seals, refer to the Operation Manual.

Series MY1B

Standard/Centralised Piping Type $\varnothing 25, \varnothing 32, \varnothing 40$

MY1B25□/32□/40□ – Stroke Z

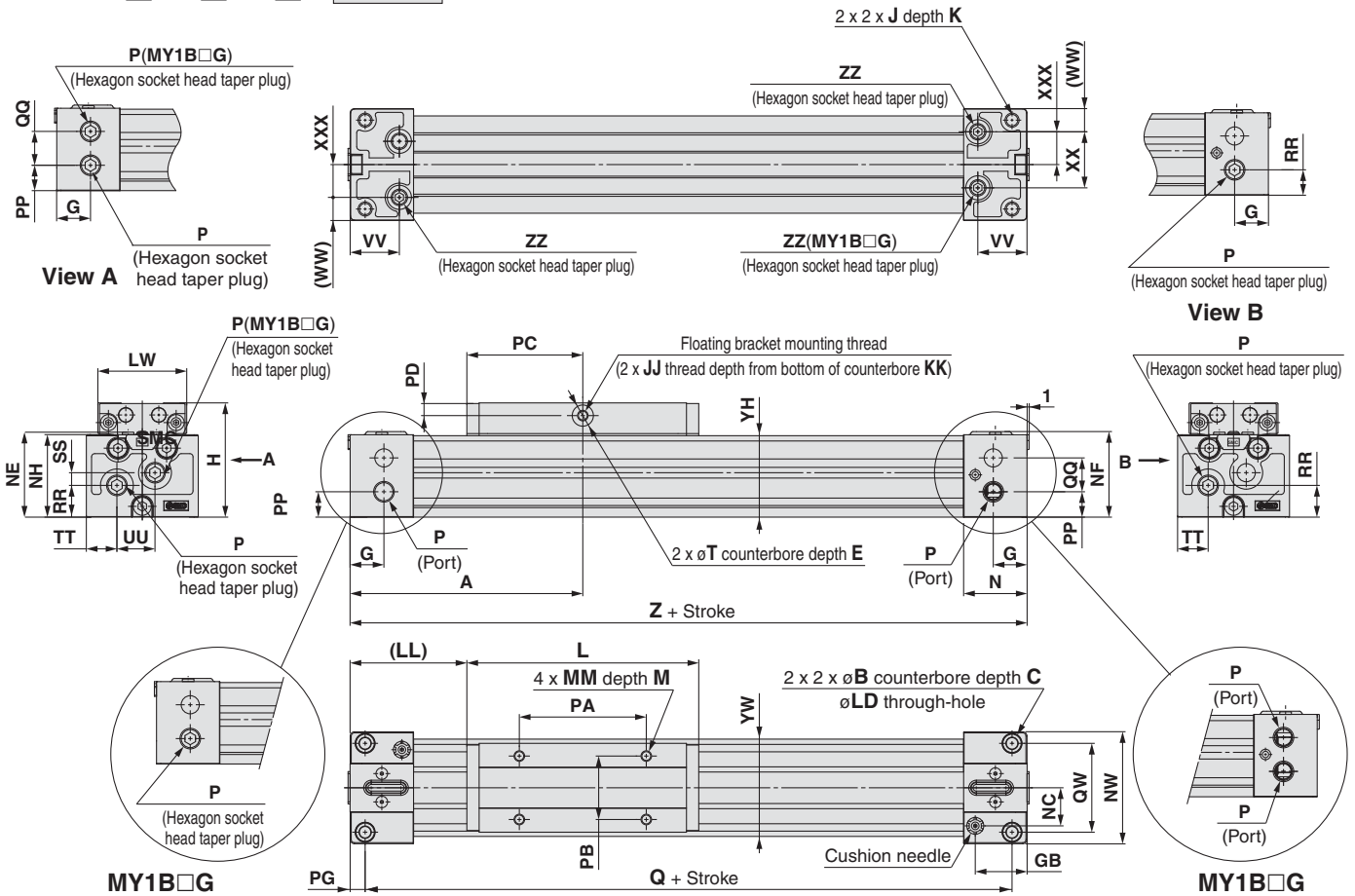

Standard piping/Centralised piping

Model	A	B	C	E	G	GB	H	J	JJ	K	KK	L	LD	LL	LW	M	MM	N	NC	NE	NF	NH	NW
MY1B25□	110	9	5.5	2	16	24.5	54	M6 x 1	M5 x 0.8	9.5	9	110	5.6	55	42	9	M5 x 0.8	30	18	40.2	40.5	39	53
MY1B32□	140	11	6.6	2	19	28.5	68	M8 x 1.25	M5 x 0.8	16	10	140	6.8	70	52	12	M6 x 1	37	22	50.2	50	49	64
MY1B40□	170	14	8.5	2	23	35	84	M10 x 1.5	M6 x 1	15	13	170	8.6	85	64	12	M6 x 1	45	26.5	62.7	62	61.5	75

Model	P	PA	PB	PC	PD	PP	PG	Q	QW	RR	T	TT	VV	WW	XXX	YH	YW	Z	ZZ
MY1B25□	Rc1/8	60	30	55	6	12	7	206	42	15	10	14.5	23.3	11	15.5	38.5	46	220	Rc1/16
MY1B32□	Rc1/8	80	35	70	10	16	8	264	51	16	10	16	28.5	12	20	48	55	280	Rc1/16
MY1B40□	Rc1/4	100	40	85	12	18.5	9	322	59	23.5	14	20	35	14	23.5	60.5	67	340	Rc1/8

Centralised piping

Model	QQ	SS	UU	XX
MY1B25□	16	6	18	26.5
MY1B32□	16	11	32	40
MY1B40□	24	12	35	47

Bottom Ported

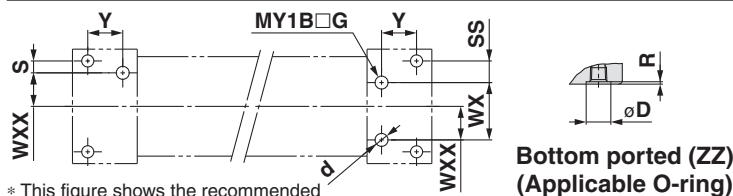

* This figure shows the recommended machining dimensions of the mounting surface when viewed from the cylinder side.

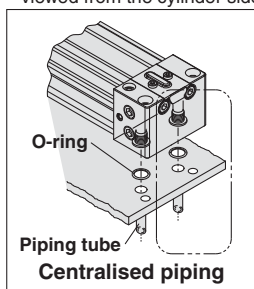

Hole Size for Centralised Piping on the Bottom (Machine the mounting side to the dimensions above.)

Standard piping/Centralised piping [mm]

Model	WXX	Y	S	d	D	R	Applicable O-ring
MY1B25□	15.5	16.2	5.5	6	11.4	1.1	C9
MY1B32□	20	20.4	5.5	6	11.4	1.1	
MY1B40□	23.5	25.9	6	8	13.4	1.1	

Centralised piping [mm]

Model	WX	SS
MY1B25□	26.5	10
MY1B32□	40	5.5
MY1B40□	47	6

Port Variations

Head cover piping connection can be freely selected to best suit different piping conditions.

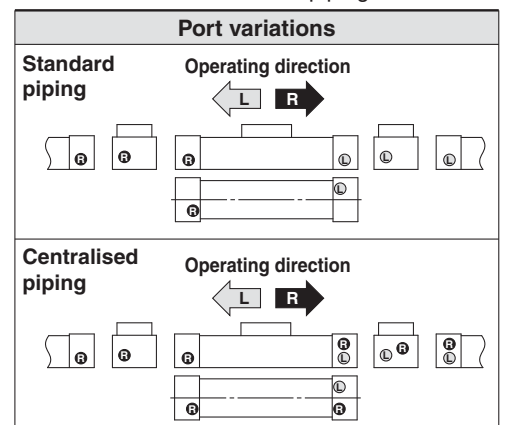

Note) Refer to the "Bottom Ported" on the left.

Stroke Adjustment Units

With adjustment bolt

MY1B **Bore size** □ – **Stroke** AZ

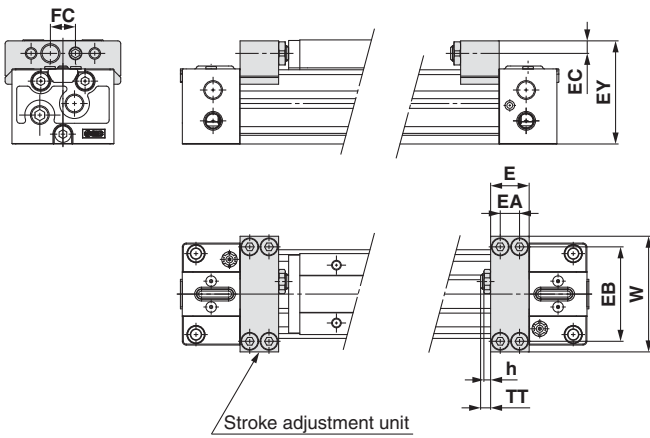

Applicable cylinder	E	EA	EB	EC	EY	FC	h	TT	W
MY1B25□	20	10	49	6.5	53.5	13	3.5	5 (Max. 16.5)	60
MY1B32□	25	12	61	8.5	67	17	4.5	8 (Max. 20)	74
MY1B40□	31	15	76	9.5	81.5	17	4.5	9 (Max. 25)	94

With low load shock absorber + adjustment bolt

MY1B **Bore size** □ – **Stroke** LZ

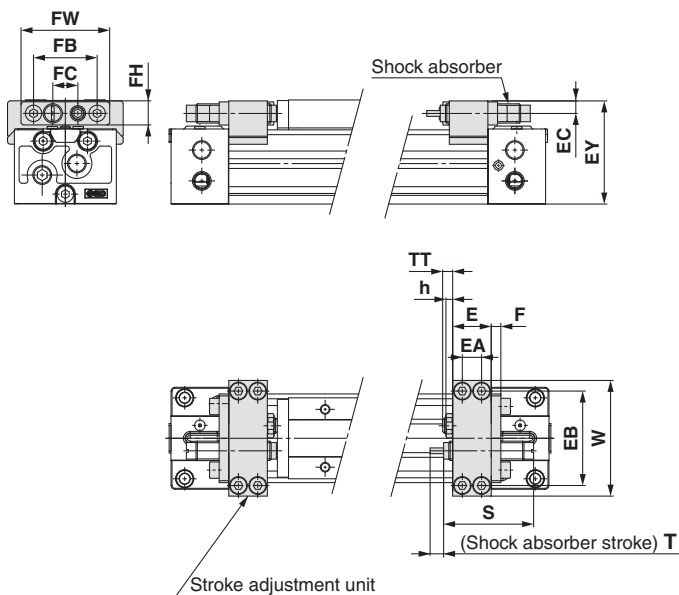

With high load shock absorber + adjustment bolt

MY1B **Bore size** □ – **Stroke** HZ

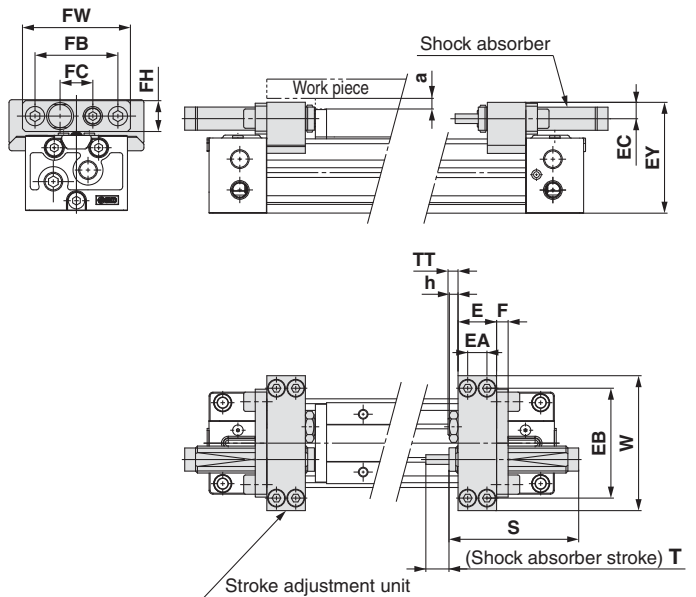

Applicable cylinder	E	EA	EB	EC	EY	F	FB	FC	FH	FW
MY1B25□	20	10	49	6.5	53.5	6	33	13	12	46
MY1B32□	25	12	61	8.5	67	6	43	17	16	56
MY1B40□	31	15	76	9.5	81.5	6	43	17	16	56

Applicable cylinder	h	S	T	TT	W	Shock absorber model
MY1B25□	3.5	46.7	7	5 (Max. 16.5)	60	RB1007
MY1B32□	4.5	67.3	12	8 (Max. 20)	74	RB1412
MY1B40□	4.5	67.3	12	9 (Max. 25)	94	RB1412

Applicable cylinder	E	EA	EB	EC	EY	F	FB	FC	FH	FW
MY1B25□	20	10	57	8.5	57.5	6	43	17	16	56
MY1B32□	25	12	74	11.5	73	8	57	22	22	74
MY1B40□	31	15	82	12	87	8	57	22	22	74

Applicable cylinder	h	S	T	TT	W	Shock absorber model	a
MY1B25□	4.5	67.3	12	5 (Max. 16.5)	70	RB1412	4.5
MY1B32□	5.5	73.2	15	8 (Max. 20)	90	RB2015	6
MY1B40□	5.5	73.2	15	9 (Max. 25)	100	RB2015	4

*Since the EY dimension of H unit is greater than the table top height (H dimension), when a work piece exceeding the full length (L dimension) of the slide table is mounted, allow a clearance of size "a" or larger at the work piece side.

Series MY1B

Side Supports

Side support A MY-S□A

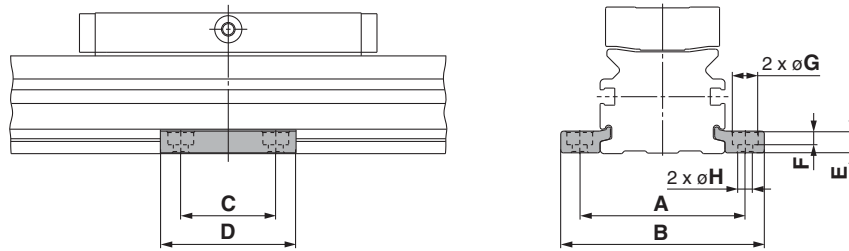

Side support B MY-S□B

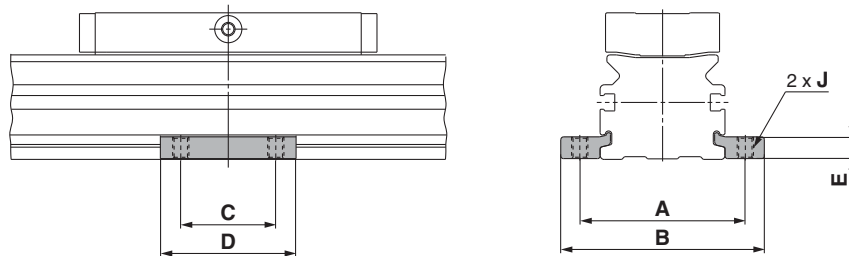

[mm]										
Part no.	Applicable cylinder	A	B	C	D	E	F	G	H	J
MY-S25 _A	MY1B25	61	75	35	50	8	5	9.5	5.5	M6 x 1
	MY1B32	70	84							
MY-S32 _A	MY1B40	87	105	45	64	11.7	6	11	6.6	M8 x 1.25

* Side supports consist of a set of right and left supports.

Guide to Side Support Application

For long stroke operation, the cylinder tube may be deflected depending on its own weight and the load. In such a case, use a side support in the middle section. The spacing (L) of the support must be no more than the values shown in the below graph.

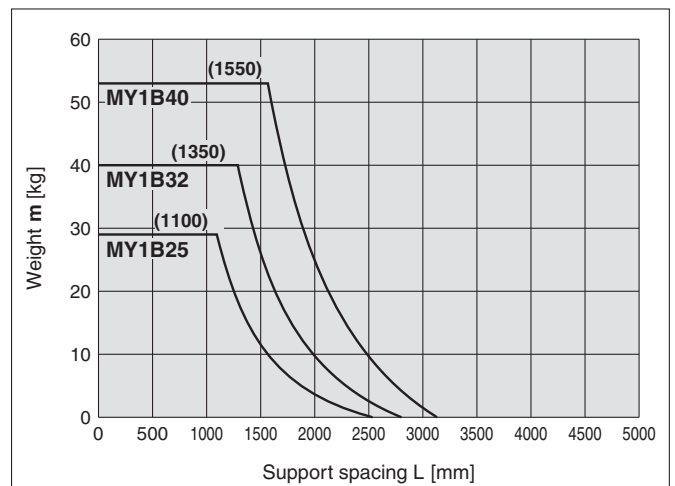
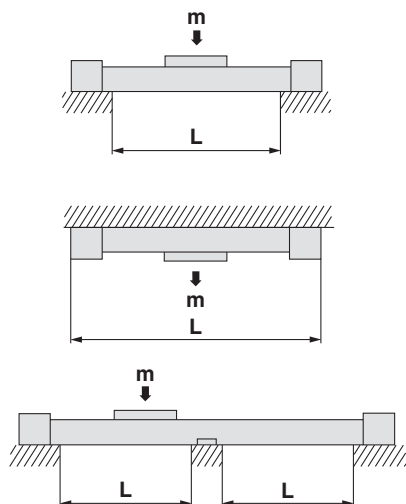

⚠ Caution

1. If the cylinder mounting surfaces are not measured accurately, using a side support may cause poor operation. Therefore, be sure to level the cylinder tube when mounting it. Also, for long stroke operation involving vibration and impact, use of a side support is recommended.
2. Support brackets are not for mounting; use them solely for providing support.

Floating Brackets MY□-J25/MY□-J32/MY□-J40

Facilitates connection to other guide systems.

L Type

Application Example

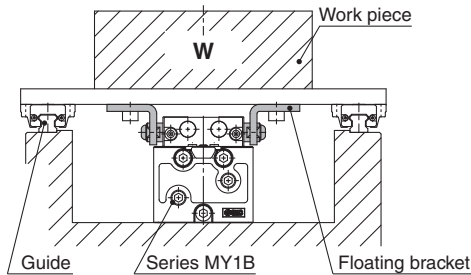

Mounting dimension

One set of brackets can be mounted in two directions for compact combinations.

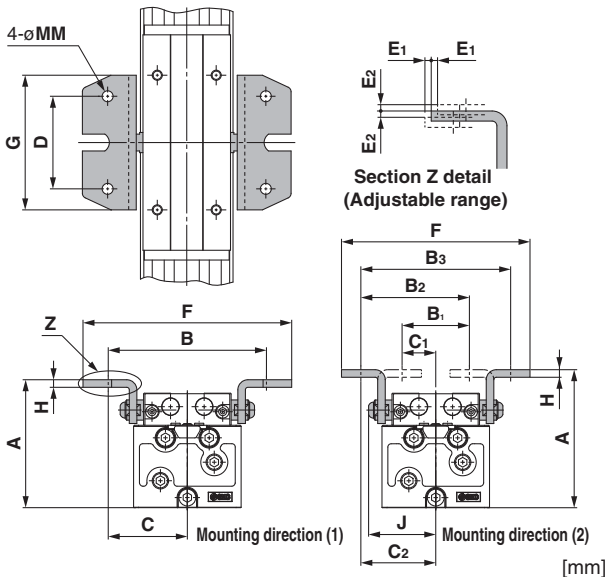

Part no.	Applicable cylinder	Common					Mounting direction (1)			
		D	G	H	J	MM	A	B	C	F
MY-J25	MY1B25□	40	60	3.2	35	5.5	63	78	39	100
MY-J32	MY1B32□	55	80	4.5	40	6.5	76	94	47	124
MY-J40	MY1B40□	74	100	4.5	47	6.5	92	112	56	144

Part no.	Applicable cylinder	Mounting direction (2)							Adjustable range	
		A	B ₁	B ₂	B ₃	C ₁	C ₂	F	E ₁	E ₂
MY-J25	MY1B25□	65	28	53	78	14	39	96	1	1
MY-J32	MY1B32□	82	40	64	88	20	44	111	1	1
MY-J40	MY1B40□	98	44	76	108	22	54	131	1	1

Note) Floating brackets consist of a set of right and left bracket.

Block Type

Application Example

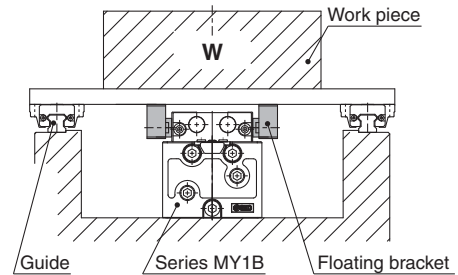

Mounting dimension

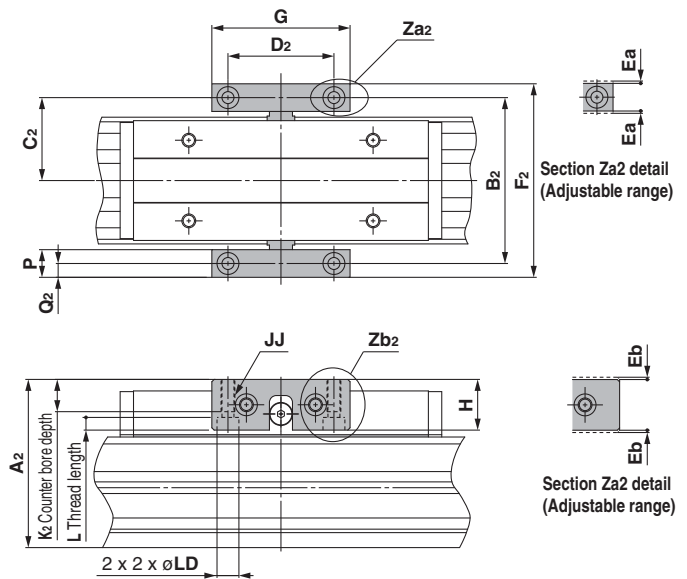

Part no.	Applicable cylinder	G	H	JJ	L	P	LD	Adjustable range	
								Ea	Eb
MYAJ25	MY1B25□	55	22	M6 x 1	5.5	12	9.5	1	1
MYAJ32	MY1B32□	60	22	M6 x 1	5.5	12	9.5	1	1
MYAJ40	MY1B40□	72	32	M8 x 1.25	6.5	16	11	1	1

Part no.	Applicable cylinder	A ₂	B ₂	C ₂	D ₂	F ₂	K ₂	Q ₂
MYAJ32	MY1B32□	73	72	36	46	84	14	6
MYAJ40	MY1B40□	93.5	88	44	55	104	19	8

Installation of Holding Bolts

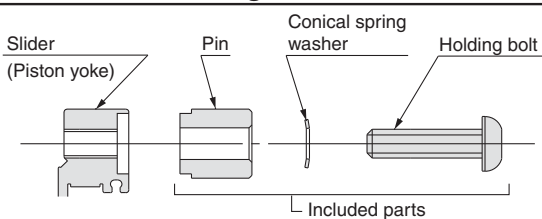

Tightening Torque for Holding Bolts

Part no.	Tightening torque [N·m]
MY-J25	3
MY-J32	5
MY-J40	5

MY□-J25 to 40 (1 set) Component Parts

Description	Material	Qty.	Note
Bracket	Rolled steel	2	Nickel plated
Pin	Carbon steel	2	Nickel plated
Conical spring washer	Carbon steel	2	Nickel plated
Holding bolt	Chromium molybdenum steel	2	Nickel plated

Floating Bracket Operating Precautions

⚠ Caution

When connecting to a load which has an external guide mechanism, use a discrepancy absorption mechanism.

Mount the external guide mounting brackets and floating brackets in a place where the required degree of freedom for the floating Y and Z axes can be secured. The thrust transmission area of the floating bracket must be fixed so that it does not partially contact with the body.

* Consult with SMC for details of floating Y and Z axes.

Series MY1B Auto Switch Mounting

Auto Switch Proper Mounting Position (Detection at Stroke End)

MY1B (Basic type)
ø25 to ø40

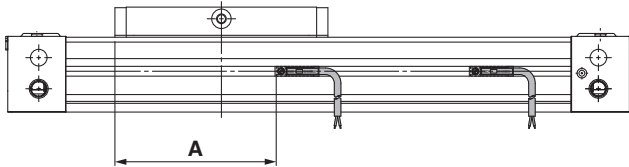

Auto Switch Proper Mounting Position [mm]

Auto switch model	D-M9□ D-M9□V D-M9□W D-M9□WV D-M9□AL D-M9□AVL		D-A9□ D-A9□V	
	A		A	
Bore size	A		A	
25	83		79	
32	116.5		112.5	
40	137.5		133.5	

Note) Adjust the auto switch after confirming the operating conditions in the actual setting.

Operating Range

MY1B (Basic type) [mm]

Auto switch model	Bore size		
	25	32	40
D-M9□/M9□V D-M9□W/M9□WV D-M9□AL/M9□AVL	5.0	5.5	5.5
D-A9□/A9□V	7.0	10.0	9.0

Note) Values which include hysteresis are for guideline purposes only, they are not a guarantee (assuming approximately 30% dispersion) and may change substantially depending on the ambient environment.

Auto Switch Mounting Bracket/Part No.

Auto switch model	Bore size [mm]
	ø25 to ø40
D-M9□/M9□V D-M9□W/M9□WV D-M9□AL/M9□AVL D-A9□/A9□V	BM Y3-016

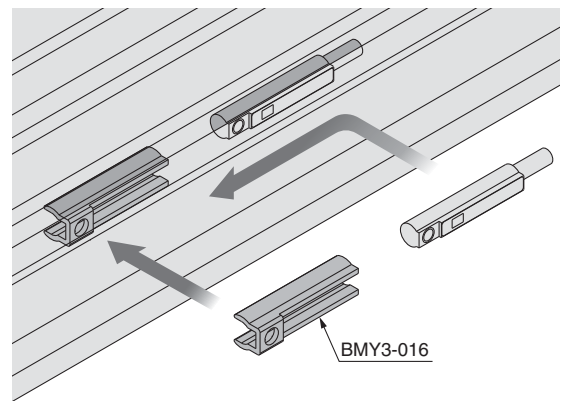

Other than the applicable auto switches listed in "How to Order", the following auto switches are mountable.

- * Normally closed (NC = b contact) solid state auto switches (D-F9G/F9H) are also available. For details, consult with SMC.
- * With pre-wired connector is also available for solid state auto switches. For details, consult with SMC.

Series MY1B

Auto Switches Connection and Example

Basic Wiring

Solid state 3-wire, NPN

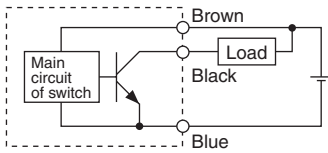

(Power supply for switch and load are separate.)

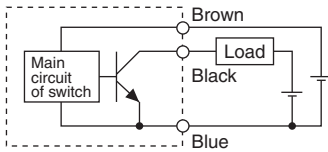

Solid state 3-wire, PNP

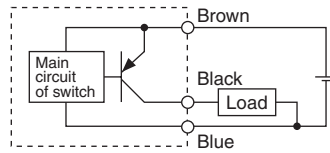

2-wire (Solid state)

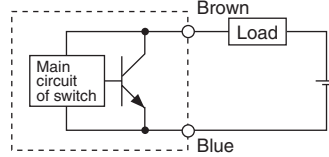

2-wire (Reed)

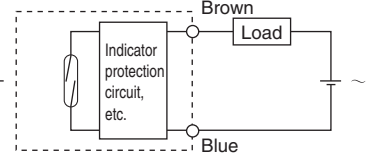

Example of Connection with PLC (Programmable Logic Controller)

•Sink input specifications 3-wire, NPN

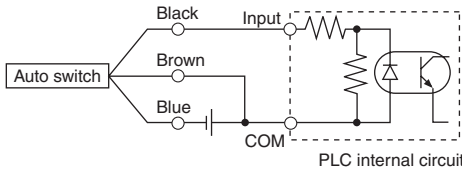

2-wire

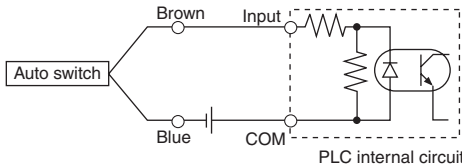

•Source input specifications 3-wire, PNP

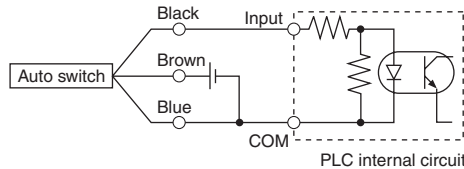

2-wire

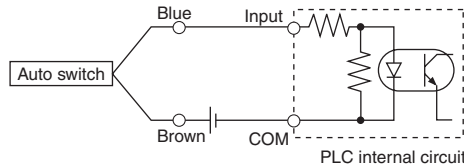

Connect according to the applicable PLC input specifications, as the connection method will vary depending on the PLC input specifications.

Example of AND (Series) and OR (Parallel) Connection

•3-wire

AND connection for NPN output (Using relays)

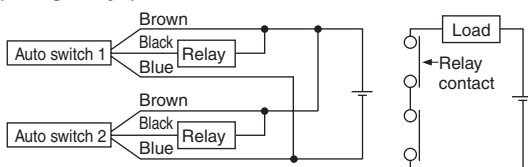

AND connection for NPN output (Performed with auto switches only)

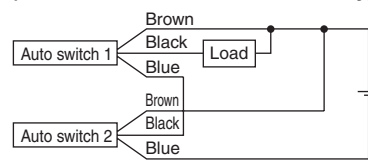

OR connection for NPN output

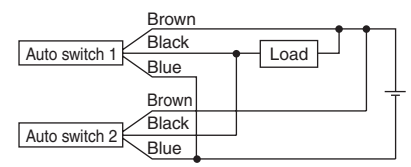

The indicator lights will light up when both of the auto switches are in the ON state.

•2-wire

2-wire with 2-switch AND connection

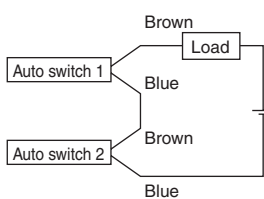

When two auto switches are connected in series, malfunction may occur because the load voltage will decrease in the ON state. The indicator lights will light up when both of the auto switches are in the ON state.

$$\begin{aligned} \text{Load voltage at ON} &= \text{Power supply voltage} - \text{Residual voltage} \times 2 \text{ pcs.} \\ &= 24 \text{ V} - 4 \text{ V} \times 2 \text{ pcs.} \\ &= 16 \text{ V} \end{aligned}$$

Example: Power supply voltage 24 VDC
Auto switch internal voltage drop 4 V

2-wire with 2-switch OR connection

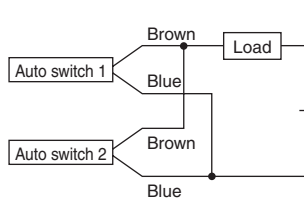

(Solid state)

When two auto switches are connected in parallel, malfunction may occur because the load voltage will increase in the OFF state.

$$\begin{aligned} \text{Load voltage at OFF} &= \text{Leakage current} \times 2 \text{ pcs.} \times \text{Load impedance} \\ &= 1 \text{ mA} \times 2 \text{ pcs.} \times 3 \text{ k}\Omega \\ &= 6 \text{ V} \end{aligned}$$

Example: Load impedance 3 kΩ
Auto switch leakage current 1 mA

(Reed)

Because there is no leakage current, the load voltage will not increase in the OFF state. However, depending on the number of auto switches in the ON state, the indicator lights may sometimes grow dim or not light up, due to the dispersion and reduction of the current flowing to the auto switches.

Series MY1B

Made to Order

Please contact SMC for detailed dimensions, specifications, and lead times.



Made-to-Order List

Series	Type	Long stroke	Shock absorber/ soft type mounted	Helical insert thread	Copper free
		-XB11	-XB22	-X168	20-
MY1B	Basic type	●	●	●	●

1 Long Stroke

Symbol
-XB11

Applicable to long strokes exceeding the standard stroke. The stroke can be set in units of 1 mm.

■ Stroke range: 2001 to 5000 mm

MY1 B **Bore size** - **Stroke** **Z** - **Auto switch** **Suffix** - XB11

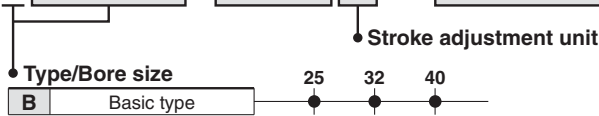

Example) MY1B40G-4999LZ-M9BW-XB11

2 Shock Absorber/Soft Type RJ Series Mounted

Symbol
-XB22

The shock absorber/soft type RJ series is mounted onto the standard cylinder, making a soft stop at the stroke end possible.

MY1 B **25** - 200 **L** Z - XB22

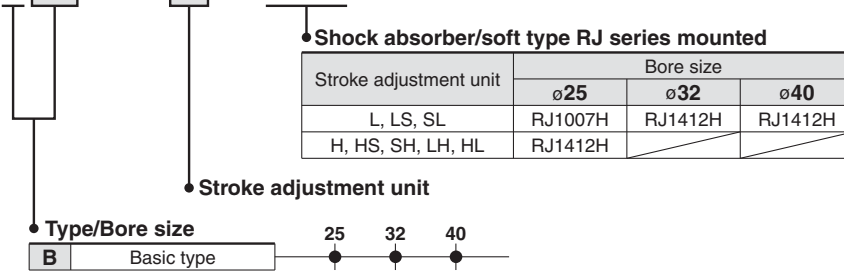

Example

● How to order stroke adjustment unit

MY-A25L1 - XB22

● Shock absorber/
soft type RJ series
mounted

● Stroke adjustment unit model.
Refer to the option table of
part numbers on page 7.

* Refer to the RJ catalogue for details about the shock absorber/soft type RJ series.

Absorption Capacity of Stroke Adjustment Units

MY1B25

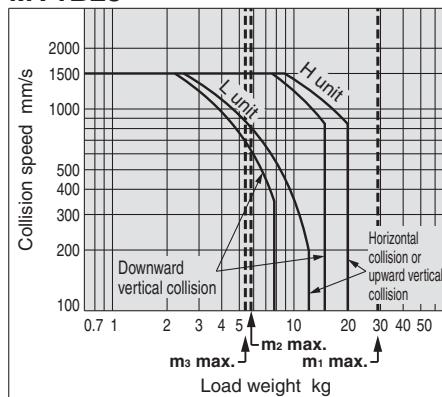

MY1B32

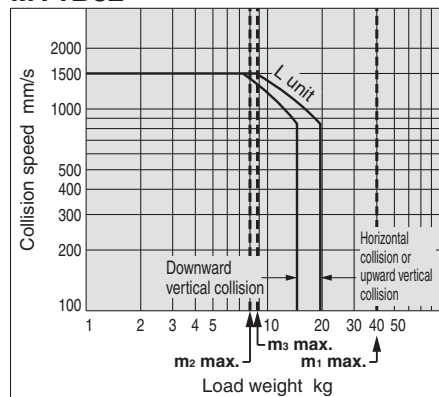

MY1B40

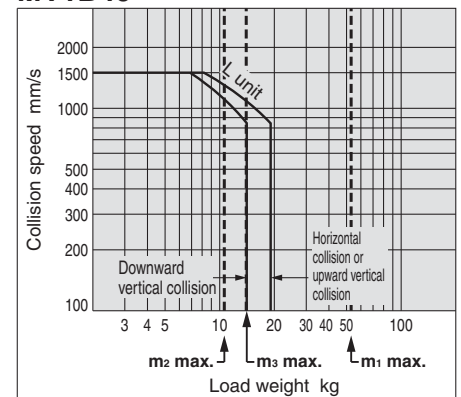

3 Helical Insert Thread Symbol **-X168**

Helical insert thread is used for the slide table mounting thread, the thread size is the same as the standard model.

MY1 B [Bore size] - [Stroke] [] Z - [Auto switch] [Suffix] - X168

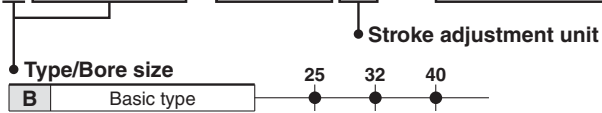

Example) MY1B40G-300LZ-M9BW-X168

4 Copper Free Symbol **20-**

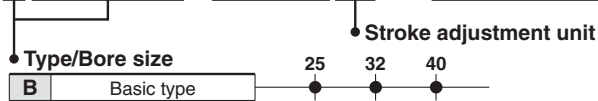

Copper free products

20-MY1 B [Bore size] - [Stroke] [] Z - [Auto switch] [Suffix]



Safety Instructions

These safety instructions are intended to prevent hazardous situations and/or equipment damage. These instructions indicate the level of potential hazard with the labels of “**Caution**,” “**Warning**” or “**Danger**.” They are all important notes for safety and must be followed in addition to International Standards (ISO/IEC)*1), and other safety regulations.

-  **Caution:** **Caution** indicates a hazard with a low level of risk which, if not avoided, could result in minor or moderate injury.
-  **Warning:** **Warning** indicates a hazard with a medium level of risk which, if not avoided, could result in death or serious injury.
-  **Danger:** **Danger** indicates a hazard with a high level of risk which, if not avoided, will result in death or serious injury.

- *1) ISO 4414: Pneumatic fluid power – General rules relating to systems.
ISO 4413: Hydraulic fluid power – General rules relating to systems.
IEC 60204-1: Safety of machinery – Electrical equipment of machines.
(Part 1: General requirements)
ISO 10218-1: Manipulating industrial robots - Safety.
etc.

Warning

- 1. The compatibility of the product is the responsibility of the person who designs the equipment or decides its specifications.**
Since the product specified here is used under various operating conditions, its compatibility with specific equipment must be decided by the person who designs the equipment or decides its specifications based on necessary analysis and test results. The expected performance and safety assurance of the equipment will be the responsibility of the person who has determined its compatibility with the product. This person should also continuously review all specifications of the product referring to its latest catalogue information, with a view to giving due consideration to any possibility of equipment failure when configuring the equipment.
- 2. Only personnel with appropriate training should operate machinery and equipment.**
The product specified here may become unsafe if handled incorrectly. The assembly, operation and maintenance of machines or equipment including our products must be performed by an operator who is appropriately trained and experienced.
- 3. Do not service or attempt to remove product and machinery/equipment until safety is confirmed.**
 1. The inspection and maintenance of machinery/equipment should only be performed after measures to prevent falling or runaway of the driven objects have been confirmed.
 2. When the product is to be removed, confirm that the safety measures as mentioned above are implemented and the power from any appropriate source is cut, and read and understand the specific product precautions of all relevant products carefully.
 3. Before machinery/equipment is restarted, take measures to prevent unexpected operation and malfunction.
- 4. Contact SMC beforehand and take special consideration of safety measures if the product is to be used in any of the following conditions.**
 1. Conditions and environments outside of the given specifications, or use outdoors or in a place exposed to direct sunlight.
 2. Installation on equipment in conjunction with atomic energy, railways, air navigation, space, shipping, vehicles, military, medical treatment, combustion and recreation, or equipment in contact with food and beverages, emergency stop circuits, clutch and brake circuits in press applications, safety equipment or other applications unsuitable for the standard specifications described in the product catalogue.
 3. An application which could have negative effects on people, property, or animals requiring special safety analysis.
 4. Use in an interlock circuit, which requires the provision of double interlock for possible failure by using a mechanical protective function, and periodical checks to confirm proper operation.

Caution

- 1. The product is provided for use in manufacturing industries.**
The product herein described is basically provided for peaceful use in manufacturing industries.
If considering using the product in other industries, consult SMC beforehand and exchange specifications or a contract if necessary.
If anything is unclear, contact your nearest sales branch.

Limited warranty and Disclaimer/ Compliance Requirements

The product used is subject to the following “Limited warranty and Disclaimer” and “Compliance Requirements”.

Read and accept them before using the product.

Limited warranty and Disclaimer

1. The warranty period of the product is 1 year in service or 1.5 years after the product is delivered, whichever is first.*2)
Also, the product may have specified durability, running distance or replacement parts. Please consult your nearest sales branch.
2. For any failure or damage reported within the warranty period which is clearly our responsibility, a replacement product or necessary parts will be provided.
This limited warranty applies only to our product independently, and not to any other damage incurred due to the failure of the product.
3. Prior to using SMC products, please read and understand the warranty terms and disclaimers noted in the specified catalogue for the particular products.

*2) Vacuum pads are excluded from this 1 year warranty.

A vacuum pad is a consumable part, so it is warranted for a year after it is delivered. Also, even within the warranty period, the wear of a product due to the use of the vacuum pad or failure due to the deterioration of rubber material are not covered by the limited warranty.

Compliance Requirements

1. The use of SMC products with production equipment for the manufacture of weapons of mass destruction (WMD) or any other weapon is strictly prohibited.
2. The exports of SMC products or technology from one country to another are governed by the relevant security laws and regulations of the countries involved in the transaction. Prior to the shipment of a SMC product to another country, assure that all local rules governing that export are known and followed.

Safety Instructions

Be sure to read “Handling Precautions for SMC Products” (M-E03-3) before using.

SMC Corporation (Europe)

Austria	☎ +43 (0)2262622800	www.smc.at	office@smc.at
Belgium	☎ +32 (0)33551464	www.smc-pneumatics.be	info@smc-pneumatics.be
Bulgaria	☎ +359 (0)2807670	www.smc.bg	office@smc.bg
Croatia	☎ +385 (0)13707288	www.smc.hr	office@smc.hr
Czech Republic	☎ +420 541424611	www.smc.cz	office@smc.cz
Denmark	☎ +45 70252900	www.smc-dk.com	smc@smc-dk.com
Estonia	☎ +372 6510370	www.smc-pneumatics.ee	smc@smc-pneumatics.ee
Finland	☎ +358 207513513	www.smc.fi	smc-fi@smc.fi
France	☎ +33 (0)164761000	www.smc-france.fr	promotion@smc-france.fr
Germany	☎ +49 (0)61034020	www.smc.de	info@smc.de
Greece	☎ +30 210 2717265	www.smc-hellas.gr	sales@smc-hellas.gr
Hungary	☎ +36 23511390	www.smc.hu	office@smc.hu
Ireland	☎ +353 (0)14039000	www.smc-pneumatics.ie	sales@smc-pneumatics.ie
Italy	☎ +39 0292711	www.smc-italia.it	mailbox@smc-italia.it
Latvia	☎ +371 67817700	www.smc-lv.lv	info@smc-lv.lv

Lithuania	☎ +370 5 2308118	www.smclt.lt	info@smclt.lt
Netherlands	☎ +31 (0)205318888	www.smc-pneumatics.nl	info@smc-pneumatics.nl
Norway	☎ +47 67129020	www.smc-norge.no	post@smc-norge.no
Poland	☎ +48 (0)222119616	www.smc.pl	office@smc.pl
Portugal	☎ +351 226166570	www.smc.eu	postpt@smc.smces.es
Romania	☎ +40 213205111	www.smcromania.ro	smcromania@smcromania.ro
Russia	☎ +7 8127185445	www.smc-pneumatik.ru	info@smc-pneumatik.ru
Slovakia	☎ +421 (0)413213212	www.smc.sk	office@smc.sk
Slovenia	☎ +386 (0)73885412	www.smc.si	office@smc.si
Spain	☎ +34 902184100	www.smc.eu	post@smc.smces.es
Sweden	☎ +46 (0)86031200	www.smc.nu	post@smc.nu
Switzerland	☎ +41 (0)523963131	www.smc.ch	info@smc.ch
Turkey	☎ +90 212 489 0 440	www.smc-pneumatik.com.tr	info@smc-pneumatik.com.tr
UK	☎ +44 (0)845 121 5122	www.smc-pneumatics.co.uk	sales@smc-pneumatics.co.uk